

138 aa101 L 3/2x2 1/2x5/16 x 8 1/2 16 ab101 L 3/2x2 1/2x5/16 x 1'-2 1/2 18 ac101 L 3/2x2 1/2x5/16 x 11 1/2 22 aa103 L 3/2x2 1/2x5/16 x 1'-5 1/2 24 aa104 L 6x3 1/2x5/16 x 6 18 aa105 L 3/2x2 1/2x5/16 x 5 1/2 3 aa106 L 4x4x3/8 x 5 3/4 9 aa107 L 3x3x3/8 x 4 4 ab107 L 3/2x2 1/2x5/16 x 1'-8 1/2

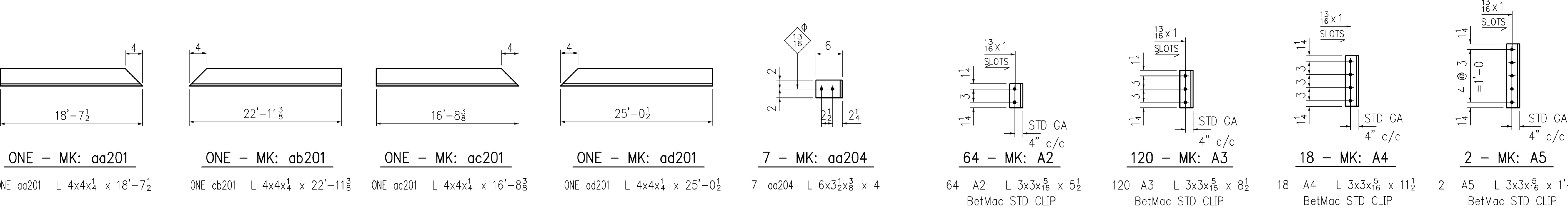

ONE aa201 L 4x4x1/4 x 18'-7 1/2 ONE ab201 L 4x4x1/4 x 22'-11 3/8 ONE ac201 L 4x4x1/4 x 16'-8 3/8 ONE ad201 L 4x4x1/4 x 25'-0 1/2 7 aa204 L 6x3 1/2x3/8 x 4 64 A2 L 3x3x5/16 x 5 1/2 BetMac STD CLIP 120 A3 L 3x3x5/16 x 8 1/2 BetMac STD CLIP 18 A4 L 3x3x5/16 x 11 1/2 BetMac STD CLIP 2 A5 L 3x3x5/16 x 1'-2 1/2 BetMac STD CLIP

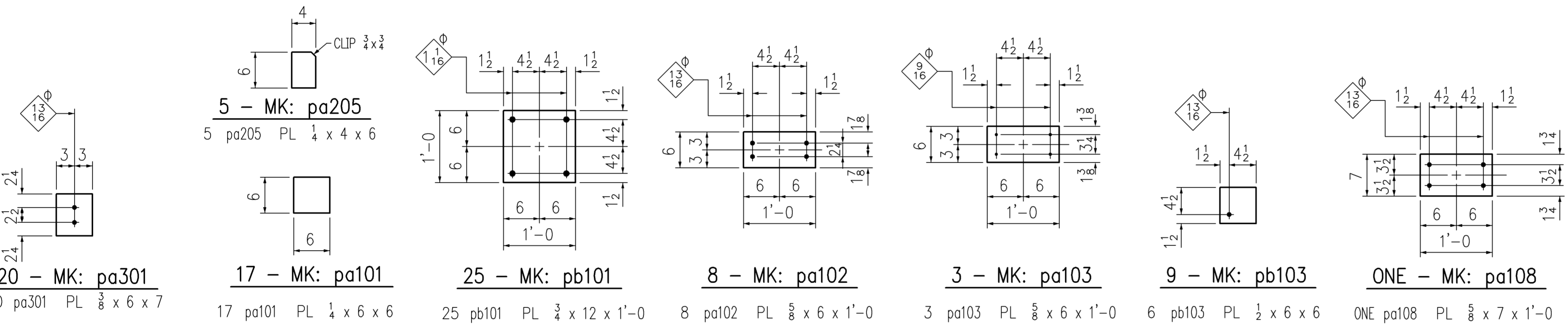

5 pa205 PL 1/4 x 4 x 6 20 pa301 PL 3/8 x 6 x 7 17 pa101 PL 1/4 x 6 x 6 25 pb101 PL 3/4 x 12 x 1'-0 8 pa102 PL 5/8 x 6 x 1'-0 3 pa103 PL 5/8 x 6 x 1'-0 9 pb103 PL 1/2 x 6 x 6 ONE pa108 PL 5/8 x 7 x 1'-0

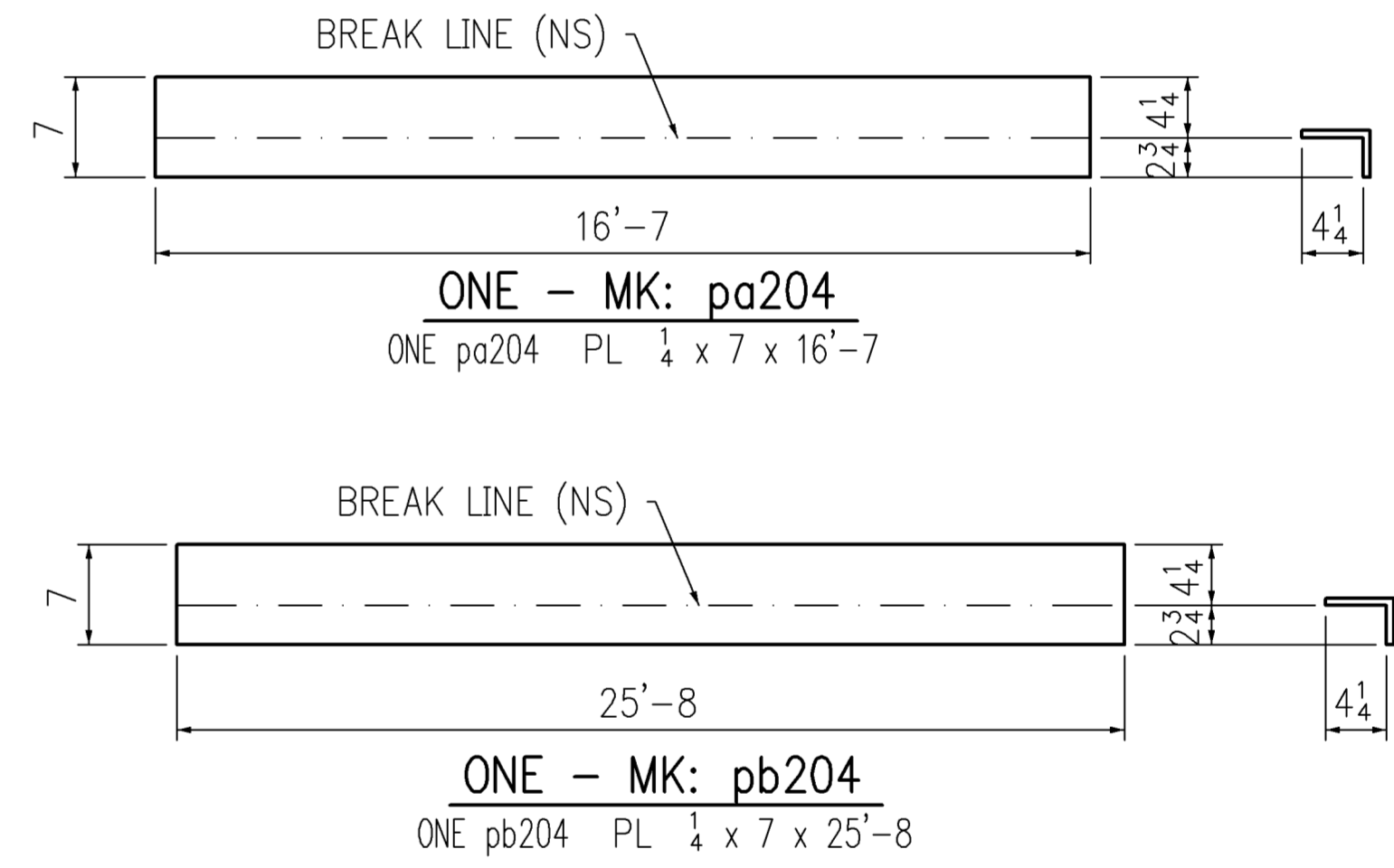

ONE pa204 PL 1/4 x 7 x 16'-7
ONE pb204 PL 1/4 x 7 x 25'-8

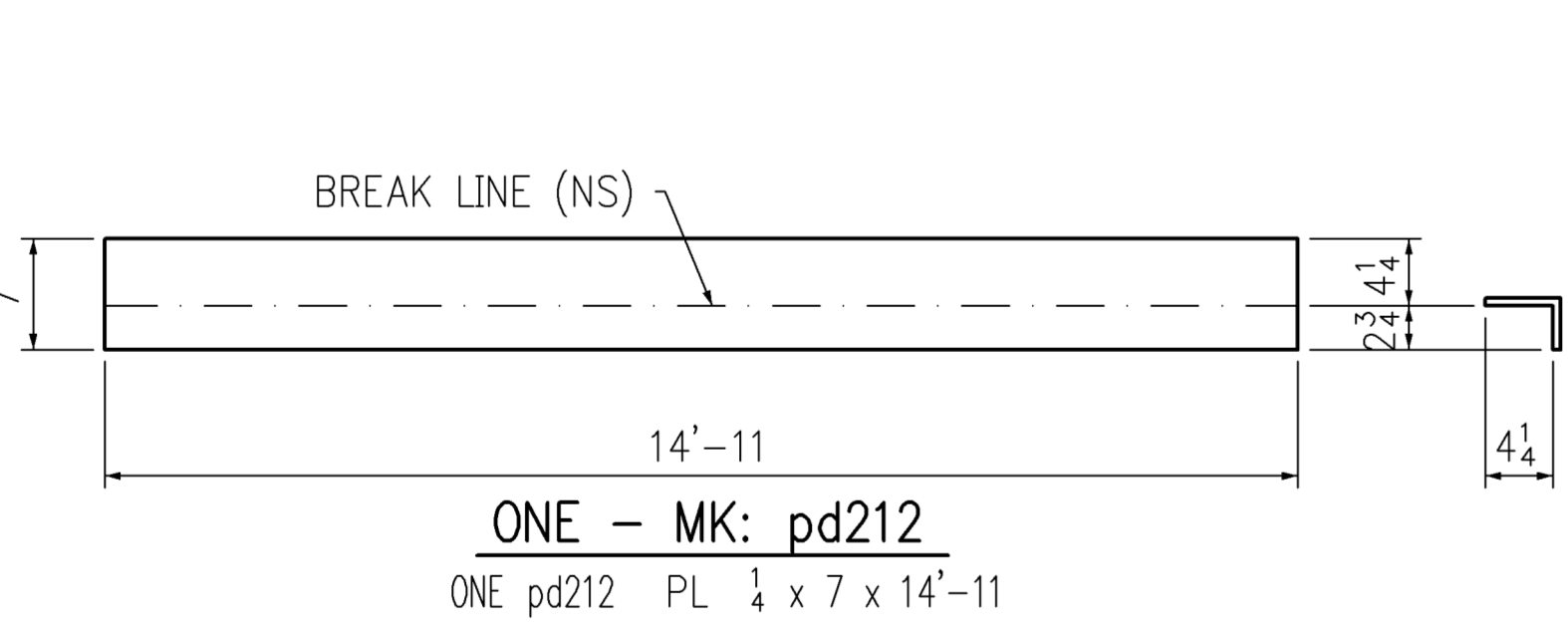

ONE pd212 PL 1/4 x 7 x 14'-11

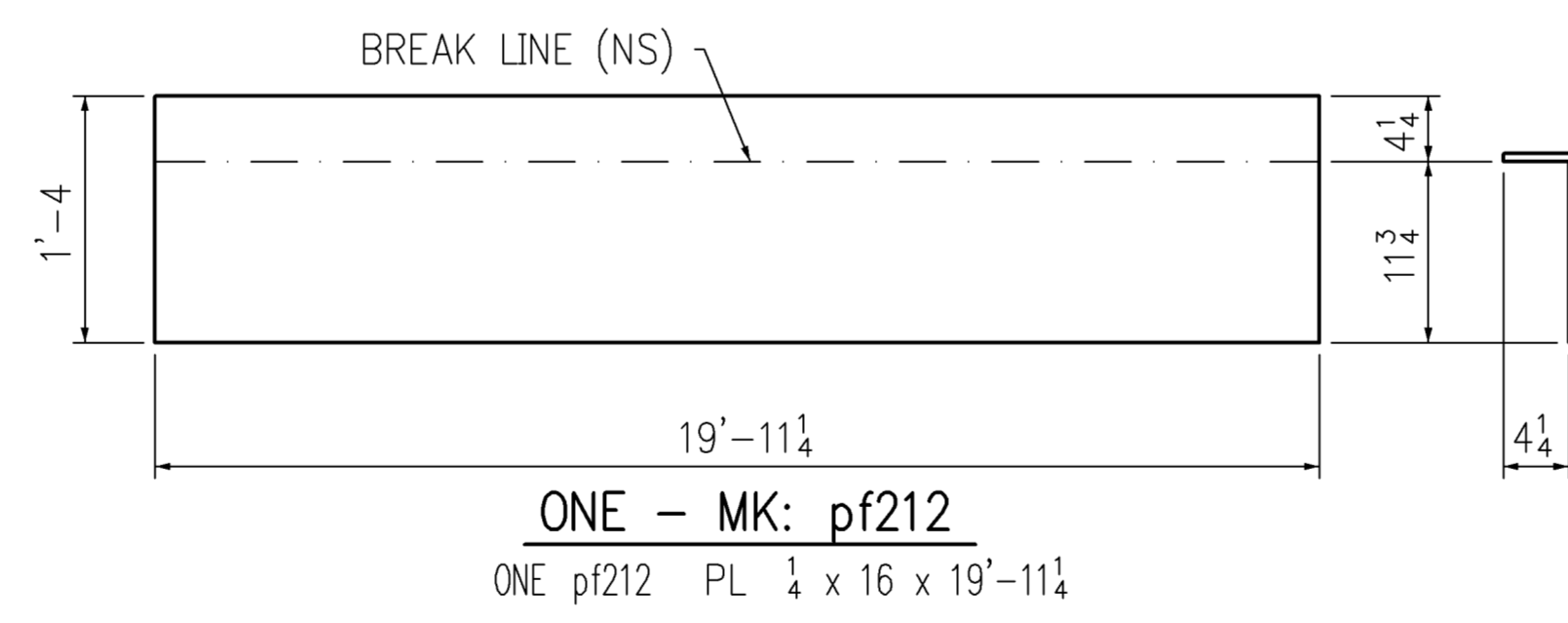

ONE pf212 PL 1/4 x 16 x 19'-11 1/4

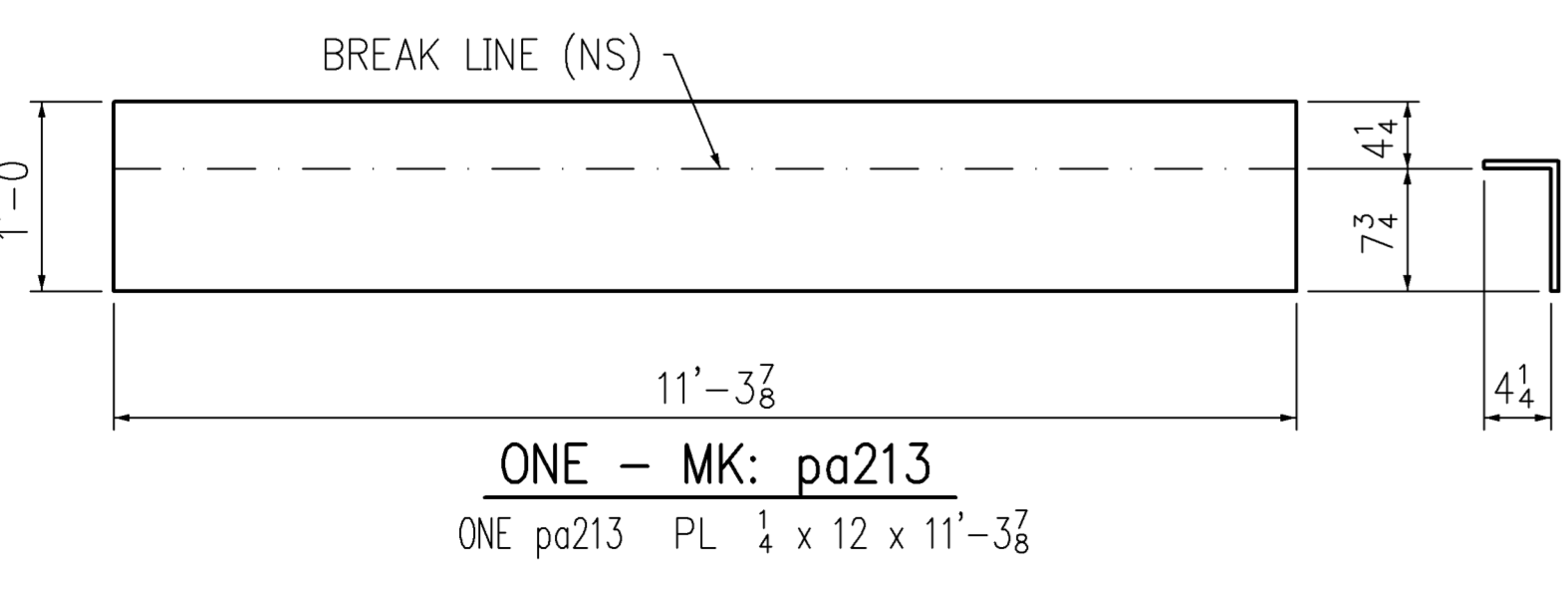

ONE pa213 PL 1/4 x 12 x 11'-3 3/8

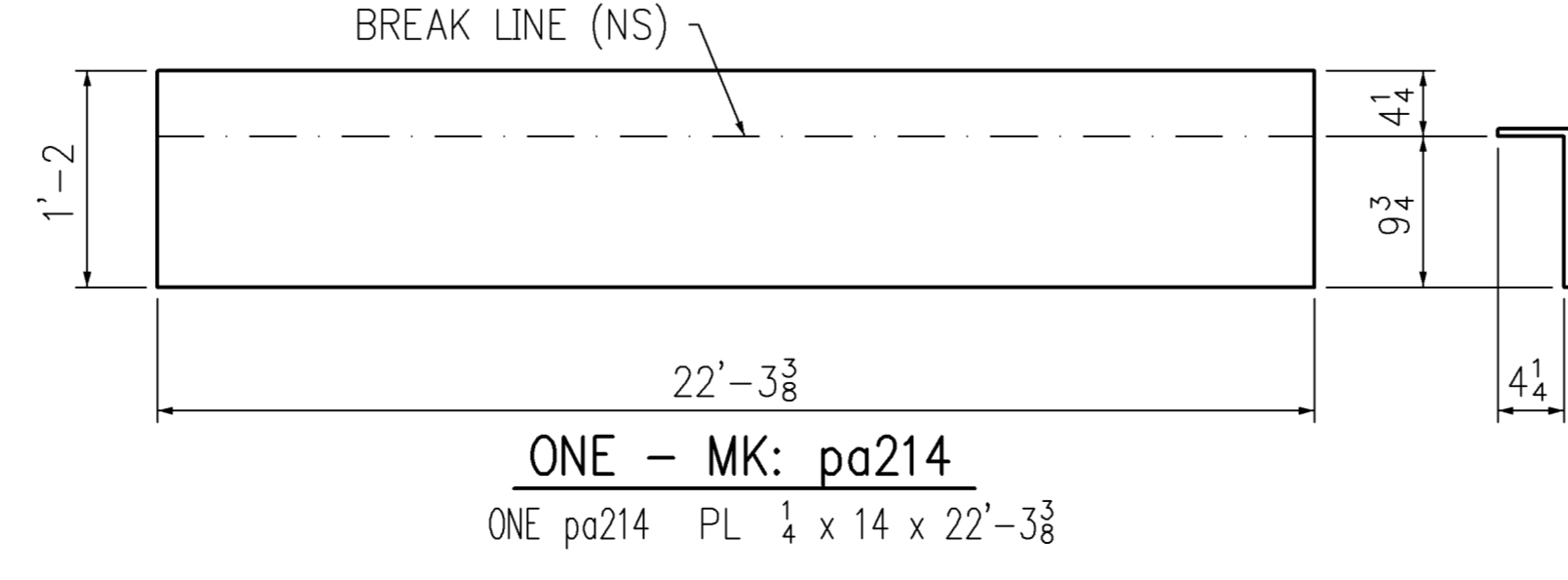

ONE pa214 PL 1/4 x 14 x 22'-3 3/8

THIS IS A SUMMARY SHEET FOR FIT-UP MAT'L SHOWN ON DETAILS + IN SHOP BILLS
DO NOT DUPLICATE FABRICATION

Gather Sheet Sample-1

CyberSTEEL
Detailing Inc.
1104 Green Tee Lane PO Box 7911 Rocky Mount, NC 27804
Phone 255.813-3911 Fax 252.977.1425